

MEC30 and 35 CIP units...

...Effective CIP cleaning of Brewery Equipment



The MEC30 (ManuMatic) and MEC35 (auto) are designed as compact, portable, units that provide full TACCT cleaning performance and flexibility for effective cleaning of brew house skids, fermenters, storage tanks and transfer lines within small to medium sized breweries.

The MEC30 (ManuMatic) is manually operated, whereas the MEC35 comes with a AB 850-series PLC and 6" Operator panel.

- Compact, portable, CIP unit
- High impact CIP cleaning of equipment & transfer lines
- Clean effectively, while reducing cleaning time, chemical & water consumption, limit waste
- Full TACCT cleaning performance & flexibility
- Multi-level CIP cleaning – from manual to fully automated
- Stand-alone or fully integrated w/ brew house PLC & HMI

Typical uses & applications:

Brewery

- Brew house skids (mashtun, brew kettles, lautertuns, whirlpools, etc.)
- Transfer / fill lines
- Fermenters
- Storage/holding tanks

MEC30 and 35 CIP units...

...Specifications in overview

Modular MEC30 and 35 series CIP cleaning units				
Process & Mechanical	Tank	Single tank	Volume:	100 gallon / 380 liter
		Atmospheric		
	Supply	CIPS pump	Pressure:	<175 psi / <12 bar
		Frequency controlled	Flow:	<75 gpm / <285 lpm
	Heating	Steam heating	Temp.:	<200 °F / <95 °C
		Plate type HX or injection	<i>Option: Electrical heating module available</i>	
	Return	CIPR pump	Flow:	<75 gpm / <285 lpm
		Self-suction/priming		
	Chemicals	Manual addition	<i>Option: Automatic dosing module (-s) for up to three (3) chemicals available</i>	
		Manual mixing		
	Instrumentation	Level, Pressure, Flow	<i>Option: High range and /or low range conductivity sensors available</i>	
		Temperature, Timer		
Materials	Product contact	AISI 316L, FDA approved elastomers		
	Non product contact	AISI 304		
Controls	MEC30	Push buttons for pump start/stop, manual readout & instrumentation gauges as well as manually operated valves		
	MEC35	Allen Bradley 850 series PLC with 6" touch screen HMI panel, E-stop & Stack-light		
		Standard Software package with recipe editor <i>Option: advanced automation platform w/Compact Logix and 12" touch screen HMI panel</i>		
Dimensions	Dimensions & weight	63" long by 30" wide by 56" tall	685 lbs / 310 kg	
Documentation	Standard documentation package	PID, Layout and Arrangement drawings		
		Component list, electrical & pneumatic schematics		
		Operator manual		
		CD w/technical literature		

Available Configurations:

- 1 – 2 chemical dosing modules
- Single thru multiple CIP supply lines
- Integrated or remote CIPR pump
- Stand-alone or integrated automation platform
- Electric or steam heating
- Waste collection

MEC30 and 35 CIP units...

...Utilities & Connections

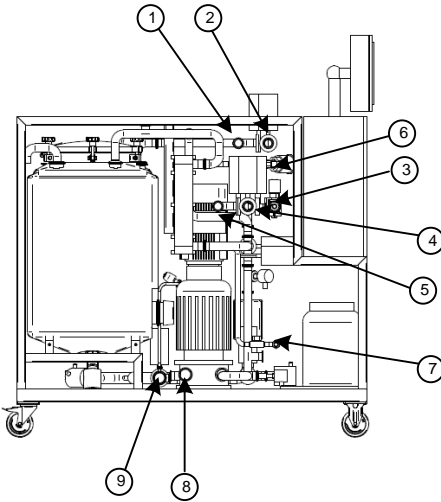

General Layout & Arrangement Drawing

1	City water	min 20 GPM @ 20 psi
2	Process water	min 20 GPM @ 20 psi
3	Compressed air	min 90 psig
4	CIP supply 1	<75 GPM @ 175 psi
5	CIP supply 2	<75 GPM @ 175 psi
6	Plant steam	min 15 psi, 100 lbs/hour
7	Condensate	<100 lbs/hour
8	CIP return	< 75 GPM
9	Drain	< 75 GPM
10	Power	3 x 480 N+PE, 60 Hz, 40/60 Amps

Other Cleaning Related Equipment & Services:

- Dynamic, high impact, spray devices
- Formulated detergents
- Spare parts
- Preventive maintenance
- CIP cycle development
- Phone support

Contact us



THE RIGHT SOLUTION

McFlusion Corp.

1480 Sandhill Drive, #6
Ancaster, ON L9G 4V5
Canada

McFlusion Inc.

2112 Case Pkwy S, #8
Twinsburg, OH 44087
USA

McFlusion Aps

Ådalen 7
DK-4600 Køge
Denmark

Phone: 1-800-341-8616 • Fax: 1-877-934-6788 • Email: mail@mcflusion.com



Satellite office – US North West

20806 NE Sierra Dr.
Bend, OR 97701
USA

Satellite office – US North East

4 Woodhaven Road
Gibbsboro, NJ 08026
USA

127.MEC30-35 – Brewery CIP. Rev.1

www.McFlusion.com